



**上海冠显光电科技有限公司**  
Shanghai Top Display Optoelectronics Co., LTD

**PRODUCTION SPECIFICATION  
OF LCD MODULE  
MODULE NO.: TL024QVV07CT-T0001A**

<b>Customer Name:</b>			
<b>Customer Part Number:</b>			
<b>Approved By:</b>		<b>Date:</b>	

<b>Prepared By</b>	<b>Checked By</b>	<b>Approved By</b>



## Table of Contents

Revision History.....	3
1 General Specifications .....	4
2 Pin Assignment .....	5
3 Absolute Maximum Ratings .....	6
4 Electrical Characteristics.....	6
5 INTERFACE TIMING .....	8
5.1 RGB interface .....	8
5.2 MCU interface.....	9
5.3 Power ON/OFF Timing.....	11
6 Optical Characteristics .....	12
7 Environmental / Reliability Test .....	16
8 Mechanical Drawing.....	17
9 Precautions For Use of LCD Modules .....	18



## Revision History

Rev	Issued Date	Description	Page	Editor
1.0	Aug 31,2017	First release	All	



## 1 General Specifications

	Feature	Specifications
<b>Display Spec.</b>	LCD type	2.4 inch
	Resolution (H*V)	240(RGB) × 320
	Technology Type	a-Si TFT
	Pixel Configuration	R.G.B. Vertical Stripe
	Display Mode	Transmissive / Normally White
	Surface Treatment	Glare
	Viewing Direction	12 o'clock
	Gray Scale Inversion Direction	6 o'clock
<b>Mechanical Characteristics</b>	OutlineDimensions (W x H x T) (mm)	48.72*70.26*4.12
	Active Area(mm)	36.72*48.96
	With /Without Touch screen	With CTP
	Match Connector Type	Soldering
	Backlight Type	LED
	Weight (g)	TBD
<b>Electrical Characteristics</b>	Interface	MPU8/16/9/18bit/RGB/SPI
	Number of color	262K
	Driver IC	ST7789V

Note 1: Viewing direction for best image quality is different from TFT definition. There is a 180 degree shift.



## 2 Pin Assignment

NO.	PIN NAME	I/O	Description
1	YU	I	Touch Panel Pin
2	XL	I	Touch Panel Pin
3	YD	I	Touch Panel Pin
4	XR	I	Touch Panel Pin
5	GND	I	Ground
6	VCI	I	Power Supply 2.8V Voltage
7	VDD3	I	Power Supply 2.8V/1.8V Voltage
8	VDD3_P(NC)	-	Set Open
9	BC_CTRL(NC)	-	Set Open
10	BC(NC)	-	Set Open
11	TE	O	Tearing effect output pin to synchronize MPU to frame writing, activated by S/W command. When this pin is not activated, this pin is low.
12-29	DB17-DB0	I/O	Display Data I/O
30	SDA	I/O	Serial input signal
31	DOTLCK	I	Dot Clock Signal for RGB Interface Operation
32	ENABLE	I	Data Enable Signal for RGB Interface Operation
33	HSYNC	I	Line Horizontal Synchronizing Signal
34	VSYNC	I	Frame Vertical Synchronizing Signal
35	RDX	I	Read strobe signal input pin
36	WRX	I	Write strobe signal input pin
37	DCX	I	Register select signal
38	CSX	I	Input pin for chip selection signal
39	RESET	I	LCM Reset input signal
40	IM0	I	Please refer to the 10 page, Select the MCU interface mode
41	IM1		
42	IM2		
43	IM3		
44	LED_A	I	LED Anode
45	LED_K1	I	LED Cathode
46	LED_K2	I	LED Cathode
47	LED_K3	I	LED Cathode
48	LED_K4	I	LED Cathode

Note1: I/O definition: I-----Input O---Output P----Power/Ground

### 3 Absolute Maximum Ratings

GND=0V, Ta= 25°C

Item	Symbol	Value	Unit
Power supply voltage for logic	V <sub>DD</sub>	1.6~3.3	V
Input voltage	V <sub>in</sub>	V <sub>DD</sub> +0.3	V
Operating temperature	Topr	-20 to 70	°C
Storage temperature	Tstg	-20 to 70	°C

### 4 Electrical Characteristics

#### 4.1 DC Characteristics (VDD=2.8V,Ta=25°C)

Item	Symbol	Min	Type	Max	Unit	Test condition
Operating voltage	V <sub>DD</sub>	2.6	2.8	3.3	V	-
Supply current	I <sub>DD</sub>	-	-	5	mA	V <sub>DD</sub> =2.8V,Ta=25°C
Input voltage	V <sub>IH</sub>	0.8V <sub>DD</sub>	-	V <sub>DD</sub>	V	-
	V <sub>IL</sub>	0	-	0.2V <sub>DD</sub>	V	
Input leakage current	I <sub>IL</sub>	-1.0	-	1.0	mA	V <sub>IN</sub> =V <sub>DD</sub> or V <sub>SS</sub>

Note: Voltage greater than above may damage the module.

All voltages are specified relative to VSS=0V.

#### 4.2 Driving Backlight

Ta=25°C

Item	Symbol	Min	Typ	Max	Unit	Remark
Forward Current	I <sub>F</sub>	--	80	100	mA	
Forward Voltage	V <sub>F</sub>	-	3.2	-	V	
Connection mode	P	--	4 Parallel	--		
LED number	/		4		pcs	

Note1: Optical performance should be evaluated at Ta=25°C only .If LED is driven by high current, high ambient temperature & humidity condition. The life time of LED will be reduced. Operating life means brightness goes down to 50% initial brightness. Typical operating life time is estimated data.

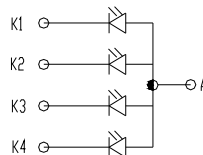

### 4.3 Block Diagram

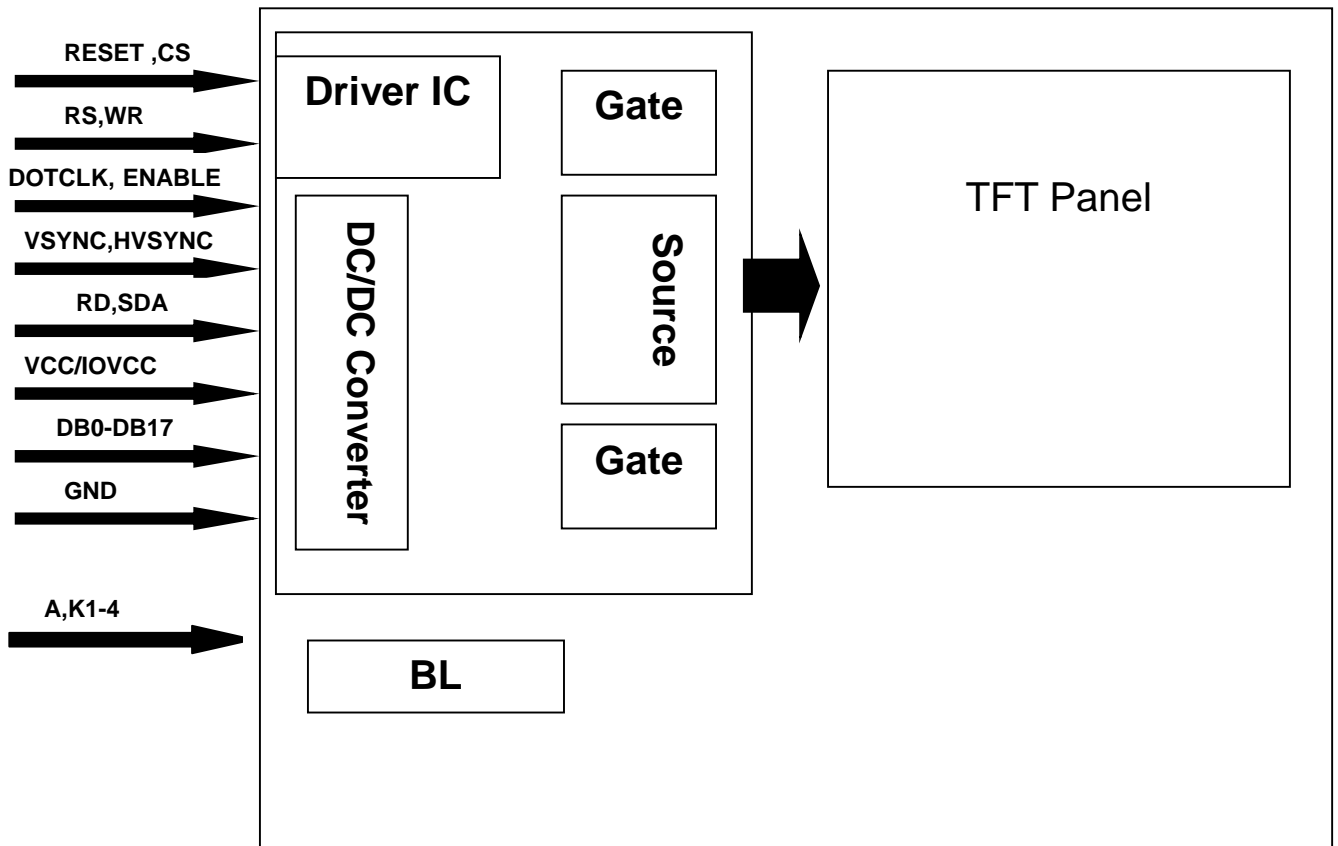

## 5 INTERFACE TIMING

### 5.1 RGB interface

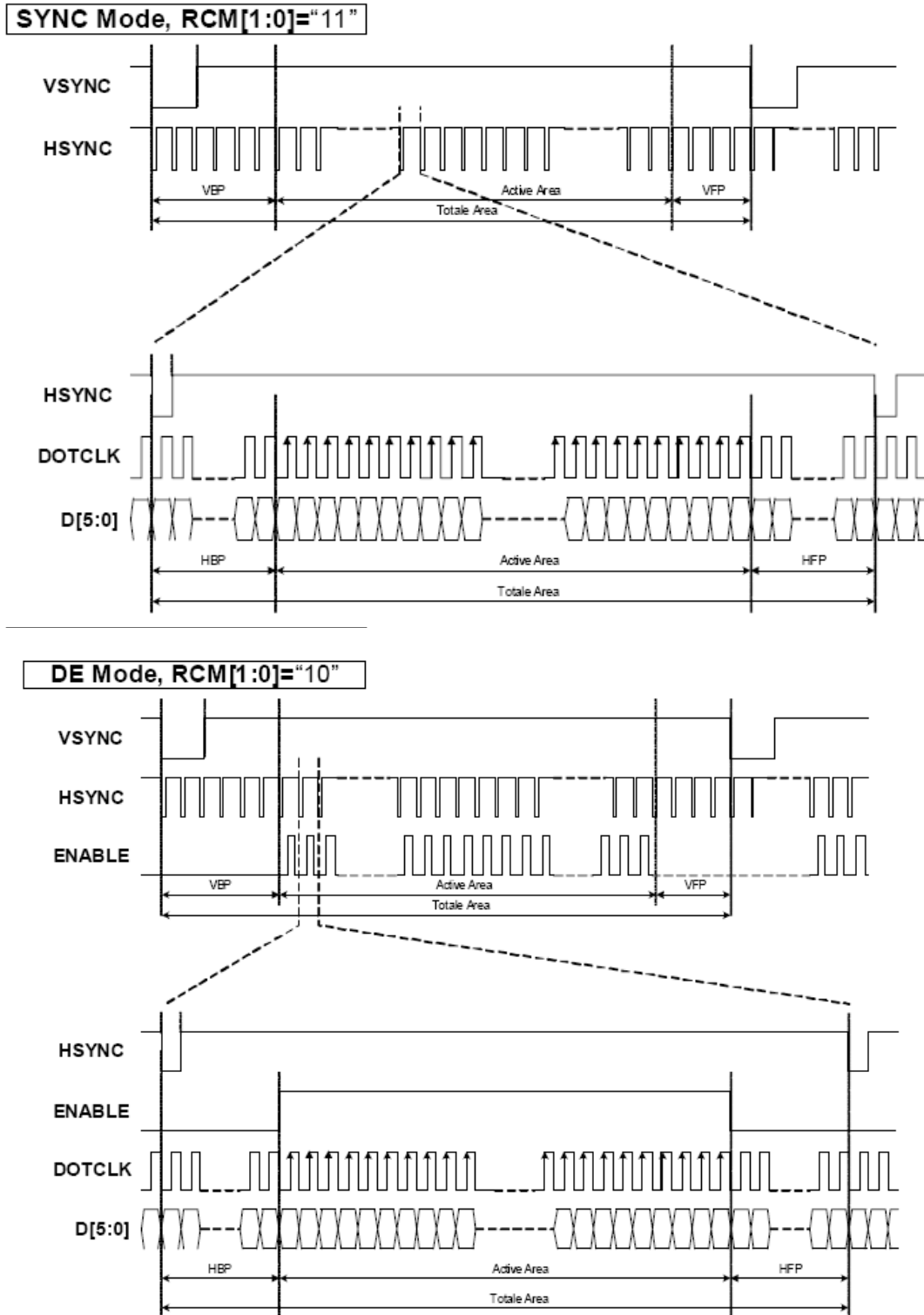



### 5.2 MCU interface

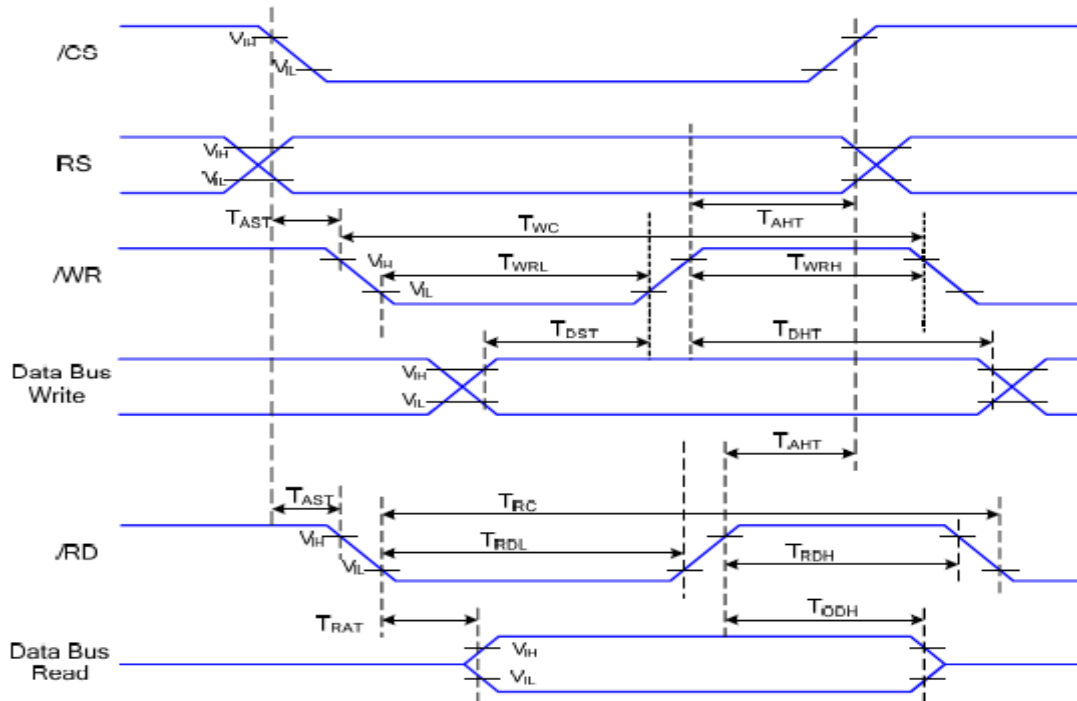

Signal	Symbol	Parameter	Min	Max	Unit	Description
RS	$T_{AST}$	Address Setup Time	10	-	ns	
	$T_{AHT}$	Address Hold Time (Write/Read)	5	-	ns	
/WR	$T_{WC}$	Write Cycle	100	-	ns	
	$T_{WRH}$	Control Pulse "H" Duration	50	-	ns	
	$T_{WRL}$	Control Pulse "L" Duration	50	-	ns	
/RD	$T_{RC}$	Read Cycle	300	-	ns	
	$T_{RDH}$	Control Pulse "H" Duration	150	-	ns	
	$T_{RDH}$	Control Pulse "L" Duration	150	-	ns	
DB[17:0]	$T_{DST}$	Data Setup Time	10	-	ns	$T_{RAT}$ , $T_{RATFM}$ : 3K ohm Pullup or Down and 30pF Parallel Cap. To GND. $T_{ODH}$ : 3K ohm Pullup or Down.
	$T_{DHT}$	Data Hold Time	15	-	ns	
	$T_{RAT}$	Read Access Time	-	100	ns	
	$T_{ODH}$	Output Disable Time	50	-	ns	



- Select the MCU interface mode

IM3	IM2	IM1	IM0	MCU-Interface Mode	DB Pin in use	
					Register/Content	GRAM
0	0	0	0	80 MCU 8-bit bus interface I	D[7:0]	D[7:0]
0	0	0	1	80 MCU 16-bit bus interface I	D[7:0]	D[15:0]
0	0	1	0	80 MCU 9-bit bus interface I	D[7:0]	D[8:0]
0	0	1	1	80 MCU 18-bit bus interface I	D[7:0]	D[17:0]
0	1	0	1	3-wire 9-bit data serial interface I	SDA: In/OUT	
0	1	1	0	4-wire 8-bit data serial interface I	SDA: In/OUT	
1	0	0	0	80 MCU 16-bit bus interface II	D[8:1]	D[17:10], D[8:1]
1	0	0	1	80 MCU 8-bit bus interface II	D[17:10]	D[17:10]
1	0	1	0	80 MCU 18-bit bus interface II	D[8:1]	D[17:0]
1	0	1	1	80 MCU 9-bit bus interface II	D[17:10]	D[17:9]
1	1	0	1	3-wire 9-bit data serial interface II	SDI: In SDO: Out	
1	1	1	0	4-wire 8-bit data serial interface II	SDI: In SDO: Out	

MPU Parallel interface bus and serial interface select

If use RGB Interface must select serial interface.

### 5.3 Power ON/OFF Timing

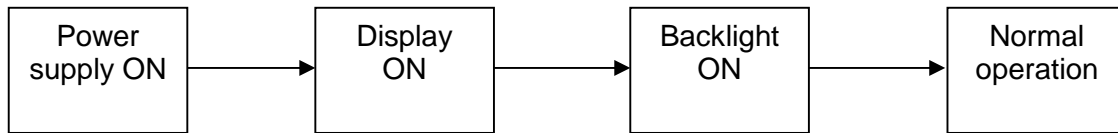
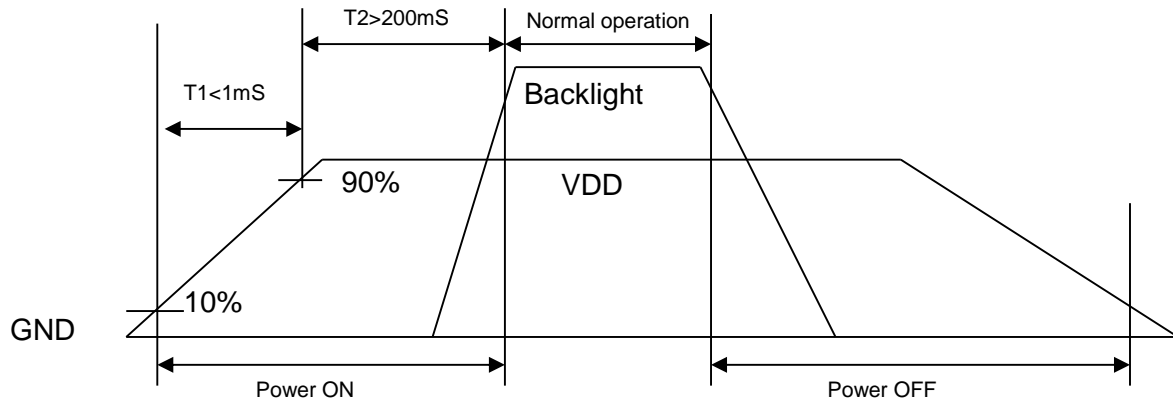

Power ON sequence

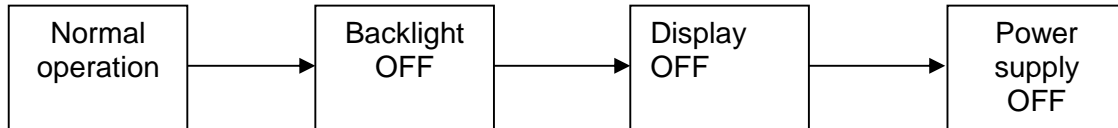

Power OFF sequence



## 6 Optical Characteristics

Ta=25°C

Item	Symbol	Condition	Min	Typ	Max	Unit	Remark
View Angles	$\theta T$	$CR \geq 10$	50	60	-	Degree	Note 2
	$\theta B$		40	50	-		
	$\theta L$		60	70	-		
	$\theta R$		60	70	-		
Contrast Ratio	CR	$\theta=0^\circ$	500	700	-	-	Note1 Note3
Response Time	$T_{ON}$	25°C	-	15	-	ms	Note1 Note4
	$T_{OFF}$						
Uniformity	U	-	70	80	-	%	Note1 Note6
NTSC	-	-	-	50	-	%	Note 5
Luminance	L		-	220	-	cd/m <sup>2</sup>	Note1 Note7

Test Conditions:

1.  $V_F=3.2V$ ,  $I_F=80mA$ , the ambient temperature is 25°C.
2. The test systems refer to Note 1 and Note 2.

**Note 1: Definition of optical measurement system.**

The optical characteristics should be measured in dark room. After 5 minutes operation, the optical properties are measured at the center point of the LCD screen. All input terminals LCD panel must be ground when measuring the center area of the panel.

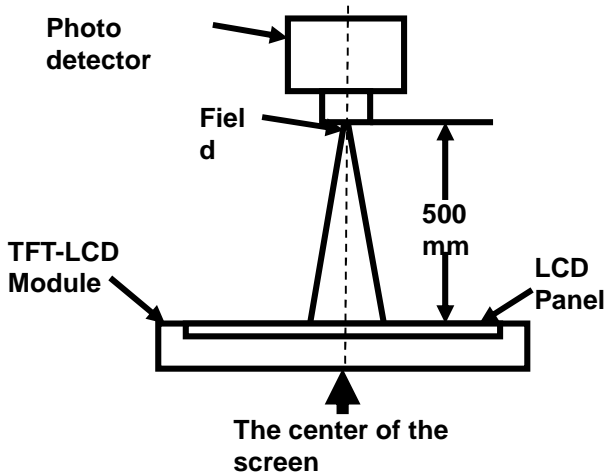

Item	Photo detector	Field
Contrast Ratio	SR-3A	1°
Luminance		
Chromaticity		
Lum Uniformity		
Response Time	BM-7A	2°

**Note 2: Definition of viewing angle range and measurement system.**

viewing angle is measured at the center point of the LCD by CONOSCOPE(ergo-80).

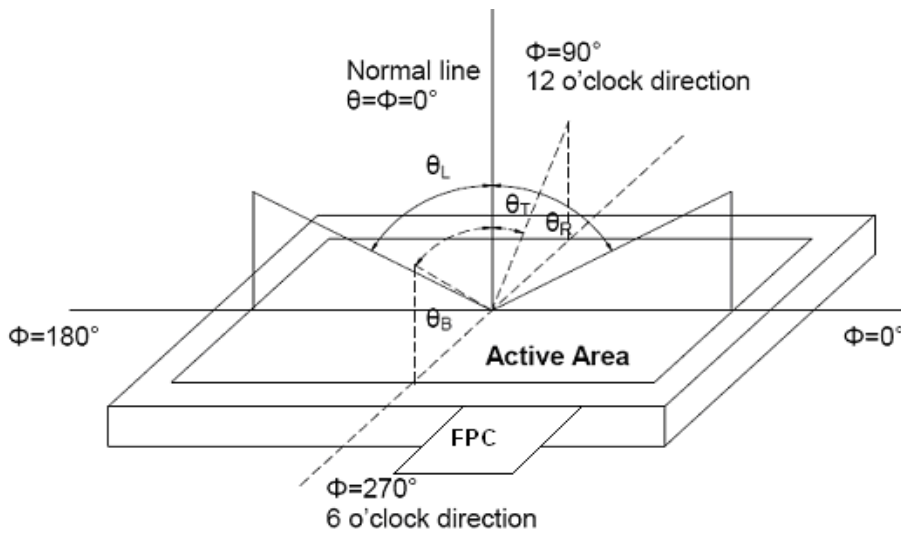

Fig. 1 Definition of viewing angle

**Note 3: Definition of contrast ratio**

$$\text{Contrast ratio (CR)} = \frac{\text{Luminance measured when LCD is on the "White" state}}{\text{Luminance measured when LCD is on the "Black" state}}$$

“White state “:The state is that the LCD should be driven by Vwhite.

“Black state”: The state is that the LCD should be driven by Vblack.

Vwhite: To be determined    Vblack: To be determined.

**Note 4: Definition of Response time**

The response time is defined as the LCD optical switching time interval between “White” state and “Black” state. Rise time (TON) is the time between photo detector output intensity changed from 90% to 10%. And fall time (TOFF) is the time between photo detector output intensity changed from 10% to 90%.

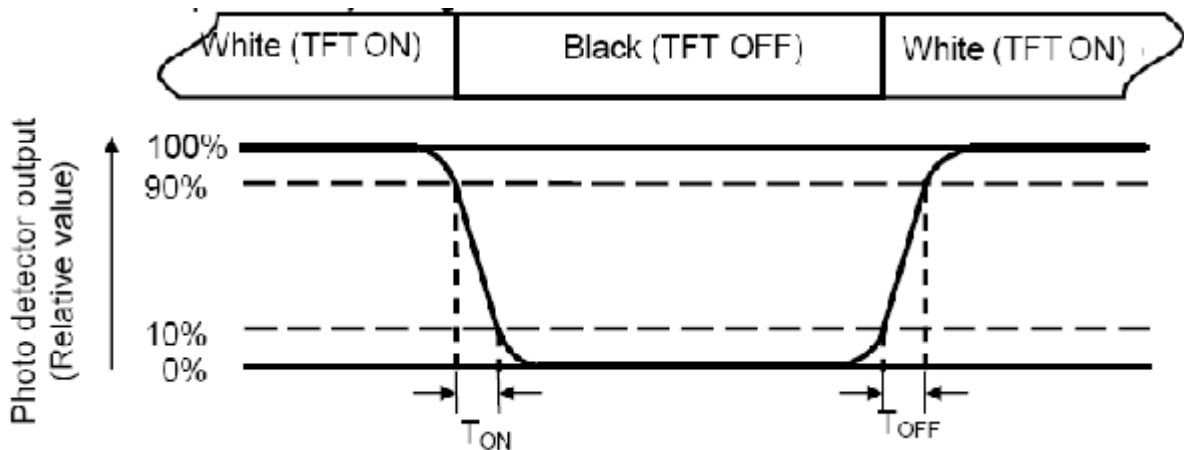

**Note 5: Definition of color chromaticity (CIE1931)**

Color coordinates measured at center point of LCD.

**Note 6: Definition of Luminance Uniformity**

Active area is divided into 9 measuring areas (Refer Fig. 2). Every measuring point is placed at the center of each measuring area.

Luminance Uniformity (U) =  $L_{min} / L_{max}$

L-----Active area length W----- Active area width

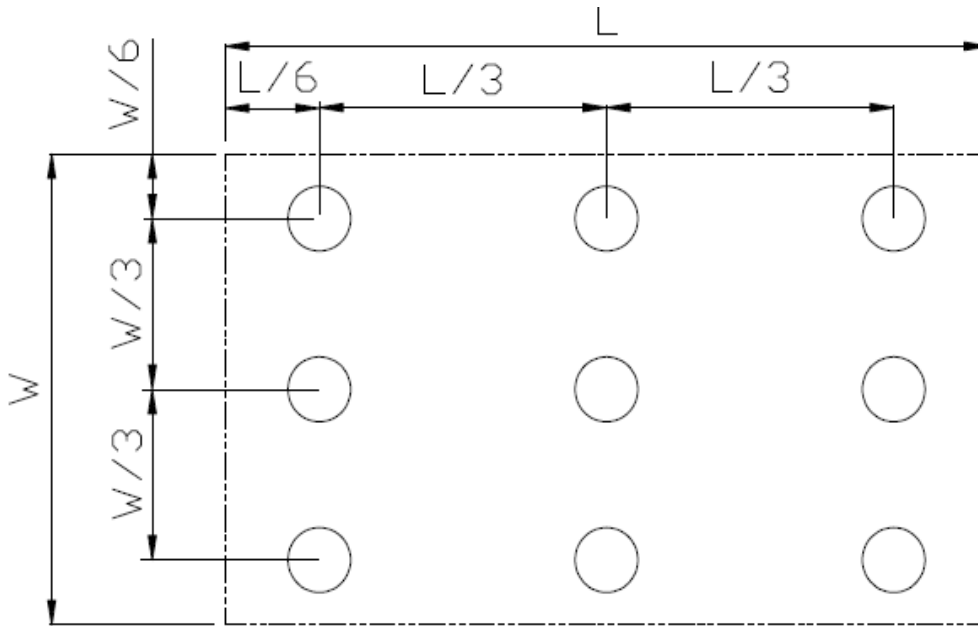

Fig. 2 Definition of uniformity

$L_{max}$ : The measured maximum luminance of all measurement position.

$L_{min}$ : The measured minimum luminance of all measurement position.

**Note 7: Definition of Luminance:**

Measure the luminance of white state at center point.



## 7 Environmental / Reliability Test

Item	Condition	Time (hrs)	Assessment
High temp. Storage	80°C	120	No abnormalities in functions and appearance
High temp. Operating	70°C	120	
Low temp. Storage	-30°C	120	
Low temp. Operating	-20°C	120	
Humidity	40°C/ 90%RH	120	
Thermal Shock(Non-operation)	-20°C → 25°C @ 70°C (0.5 hour → 5 min @ 0.5 hour)	10cycles	





# 8 Mechanical Drawing

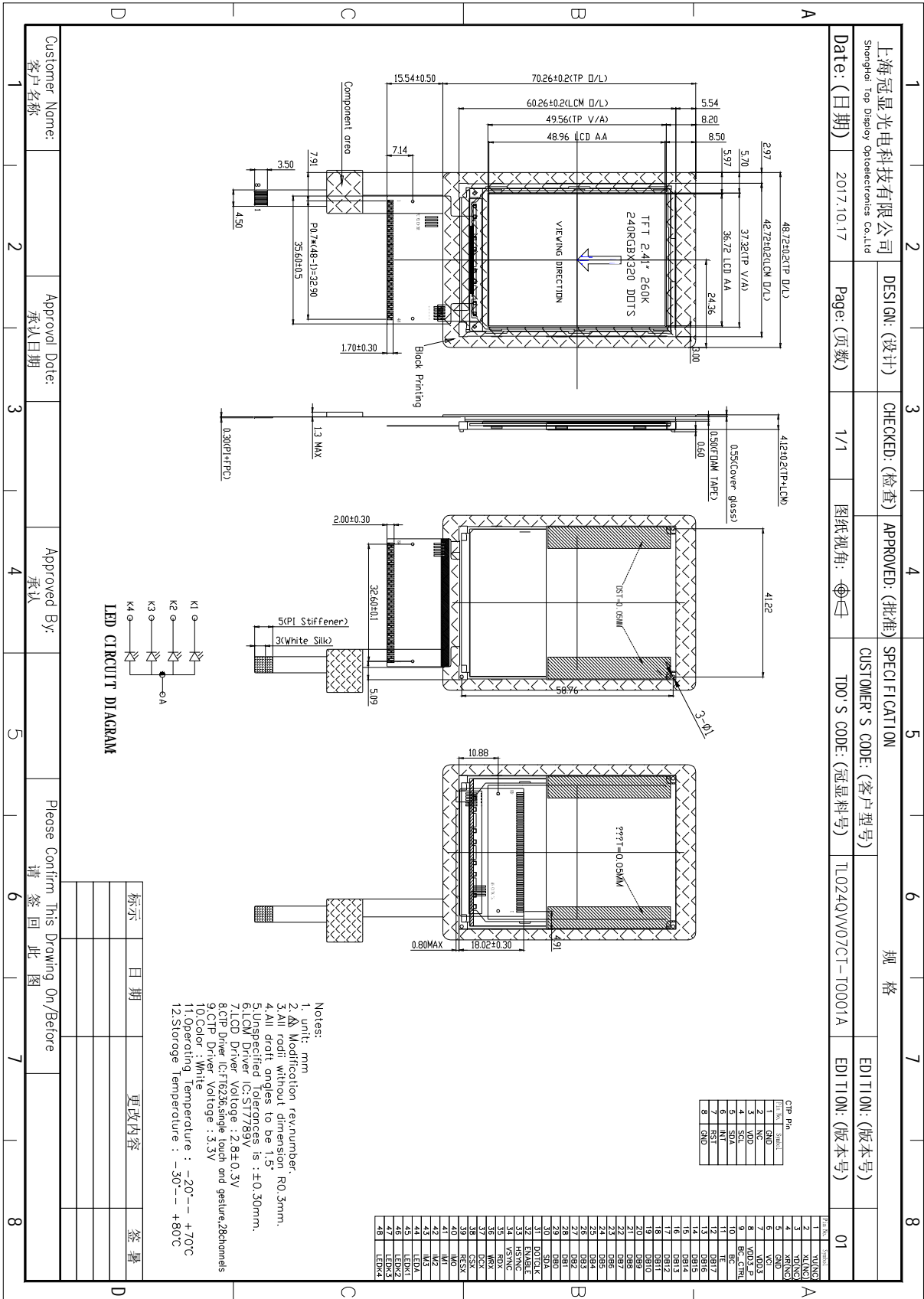



## 9 Precautions For Use of LCD Modules

### 9.1 Handling Precautions

9.1.1.1 The display panel is made of glass. Do not subject it to a mechanical shock by dropping it from a high place, etc.

9.1.1.2 If the display panel is damaged and the liquid crystal substance inside it leaks out, be sure not to get any in your mouth, if the substance comes into contact with your skin or clothes, promptly wash it off using soap and water.

9.1.1.3 Do not apply excessive force to the display surface or the adjoining areas since this may cause the color tone to vary.

9.1.1.4 The polarizer covering the display surface of the LCD module is soft and easily scratched. Handle this polarizer carefully.

9.1.1.5 If the display surface is contaminated, breathe on the surface and gently wipe it with a soft dry cloth. If still not completely clear, moisten cloth with one of the following solvents:

- Isopropyl alcohol
- Ethyl alcohol

Solvents other than those mentioned above may damage the polarizer. Especially, do not use the following:

- Water
- Ketone
- Aromatic solvents

9.1.1.6 Do not attempt to disassemble the LCD Module.

9.1.1.7 If the logic circuit power is off, do not apply the input signals.

9.1.1.8 To prevent destruction of the elements by static electricity, be careful to maintain an optimum work environment.

9.1.1.9 Be sure to ground the body when handling the LCD Modules.

9.1.1.10 Tools required for assembly, such as soldering irons, must be properly ground.

9.1.1.11 To reduce the amount of static electricity generated, do not conduct assembly and other work under dry conditions.

9.1.1.12 The LCD Module is coated with a film to protect the display surface. Be care when peeling off this protective film since static electricity may be generated.

9.1.1.13 Storage precautions

9.1.1.14 When storing the LCD modules, avoid exposure to direct sunlight or to the light of fluorescent lamps.

9.1.1.15 The LCD modules should be stored under the storage temperature range. If the LCD modules will be stored for a long time, the recommend condition is:

9.1.1.16 Temperature : 0°C ~ 40°C      Relatively humidity: ≤80%

9.1.1.17 The LCD modules should be stored in the room without acid, alkali and harmful gas.

### 9.2 Transportation Precautions

The LCD modules should be no falling and violent shocking during transportation, and also should avoid excessive press, water, damp and sunshine.